

CATALOGO GENERAL DE TENSORES DE CORREA



distribuidora rio













Nuestros productos son desarrollados por un departamento de ingeniería para ofrecer óptima calidad controlada.

**Exija productos NeoTek,
compruebe su calidad
y nos elegirá siempre.**

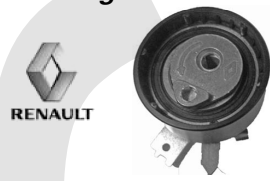
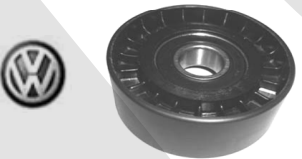
NEOTEK

NeoTek

100% Argentino









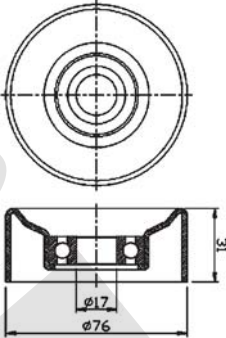

NUEVOS TENSORES DE CORREAS con rodamientos" SKF o NSK "		
<p>Astra/Corsa/Vectra/Zafira 16 Val.</p> 	<p>Astra 1.4-1.6/Vectra1.6/Corsa1.2/Fun</p> 	<p>Aveo / Corsa II</p> 
Codigo 2389 (74x25x17mm.)	Codigo 2390	Codigo 2391 (56x25x8 mm.)
Polea tensora correa dentada	Tensor correa auxiliar	Polea tensora correa correa Poly V
SKF:VKM-15214 - N° Orig.90412783	SKF:VKM-35008	Reparación de Kit GM 02635393
<p>Corsa I y II / Meriva / Agile / Celta Fun / Cobalt 8 valvulas</p> 	<p>Renault Kangoo</p> 	<p>Clio I/Laguna1.8/2.0/Megane 2.0 R-19 Mot.1.8</p> 
Codigo 2392	Codigo 3259 (57x26 mm.)	Codigo 3260 (70x28x10 mm.)
Engranaje de cigüeñal	Polea alternador correa poly-V	Polea tensora
N° Original 90502545	(Plástica)	SKF:VKM-36006 - N°orig.7700851321
<p>Clio II y III / Megane / Scenic II Kangoo todos Mot.1.5 DCI</p> 	<p>Gol/Golf/Polo/Audi</p> 	<p>Renault Clio II / Megane II Peugeot 206/306/405/406</p> 
Codigo 3261 (61x32 mm.)	Codigo 4276P (70x24x17 mm.)	Codigo 5375M (65x26x17 mm.)
Polea tensora correa dentada	Polea correa poly-V (Plástica)	Polea tensora alternador
SKF:VKM-16102 - N°orig.8200102941	INA:F-567275	(Metálica)
<p>Peugeot 206/306/405/406/ Partner / Boxer</p> 	<p>Peugeot 307 1.4-1.6 Diesel Citroen C3/C4/Berlingo/Fiesta 1.4</p> 	<p>Peugeot 206/306/405/406 1.9 Diesel Berlingo/Xantia Diesel</p> 
Codigo 5364P (57x26 mm.)	Codigo 5387 (60x26x17 mm.)	Codigo 5331P (70x27 mm.)
Polea alternador (Plástica)	Polea tensora inversión poly-V	Polea alternador/aire ac./dir.hidraulica
N° original PF-GF40/MD23	N° original 5751.E8	SKF:VKM-33013 (Plástica)
<p>Peugeot 206 / 306 II / Partner Citroen Berlingo /Xsara Mot.1.9 Dsl</p> 	<p>Peugeot 307 / 206 / Partner Citroen Berlingo / Xsara Mot.1.4-1.6</p> 	
Codigo 5390 (60x25x17 mm.)	Codigo 5391 (60x26.4x10 mm.)	
Polea tensora inversión correa auxiliar	Polea tensora inversión correa auxiliar	
SKF:VKM-33031 (Plástica) N°5751.93	SKF:VKM-33100 (Plástica) N°5751.98	

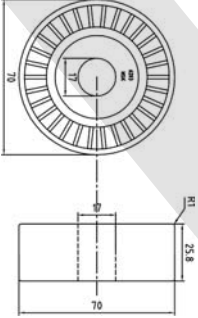

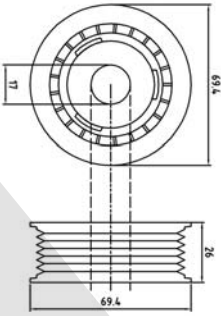
Catálogo Tensores de Correa

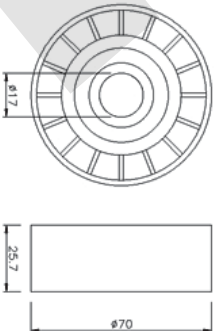





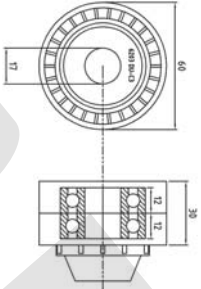



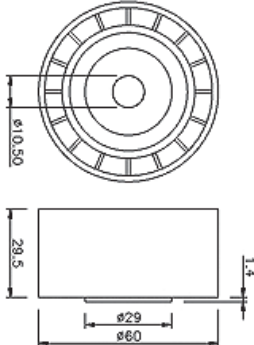

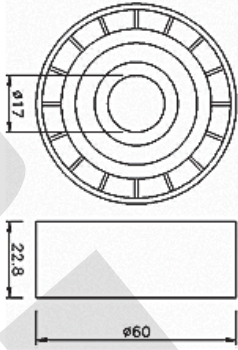

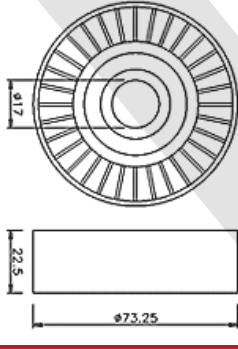
NeoTek

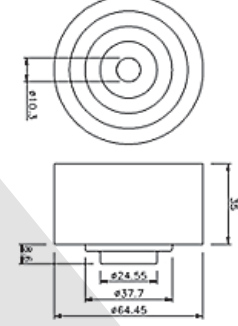



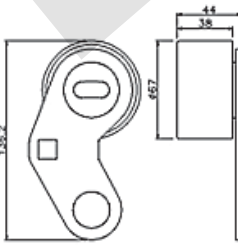





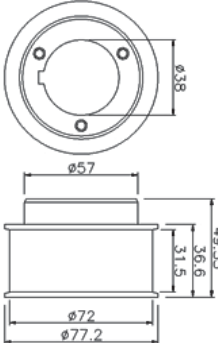







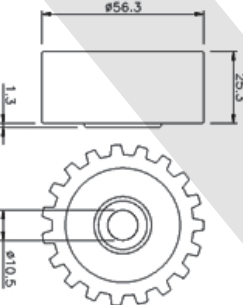

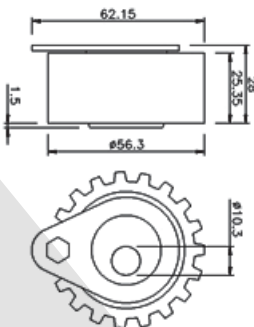

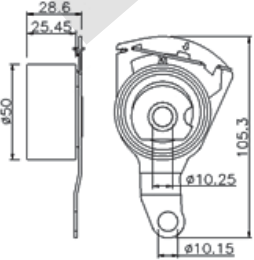

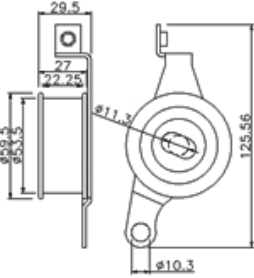

distribuidora rio

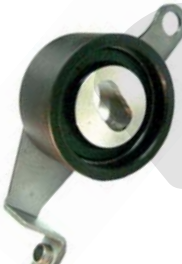
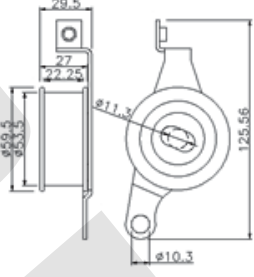

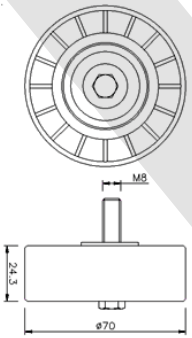

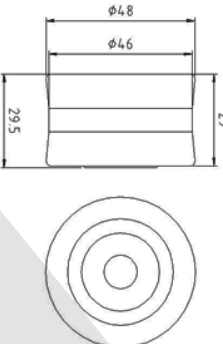

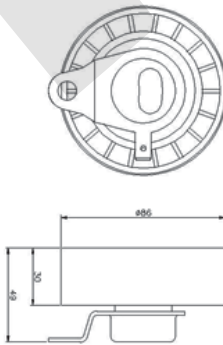

Código/Imágen	Plano/Medidas	Correa	Códigos Original/SKF/INA	Descripción del artículo	Aplicación	Marca
<p>1858</p>  <p>Ø76 X 31 X Ø17</p>		Poly-V	377-145-299	Polea lisa de tensor fija auxiliar	Ecosport 2.0 Duratec Ranger 3.0	
<p>5157</p>  <p>Ø70 X 26 X Ø17</p>		Alternador	<p>----</p> <p>VKM35020 533001710</p>	Tensor fijo de correa	SPRINTER II CDI CLASE C	
<p>5158</p>  <p>Ø64 X 23 X Ø17</p>		Poly-V	<p>----</p> <p>VKM31041 532016010</p>	-----	SPRINTER PASSAT 2.5 TUAREG 3.0 CROSSFIRE AUDI A4/A6/ Q5/Q7	
<p>1645</p>  <p>Ø70 X 26 X Ø17</p>		Poly-V	<p>7044044X</p> <p>VKM33013</p> <p>----</p>	Tensor fijo de correa	FIESTA DIESEL DUNA CORSA	  

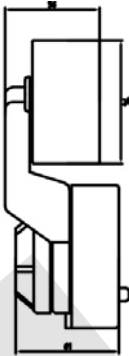

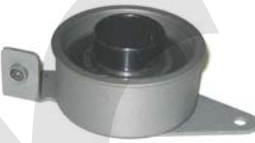
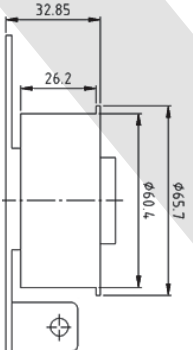

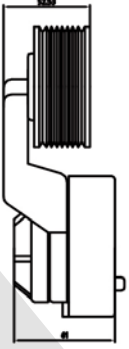

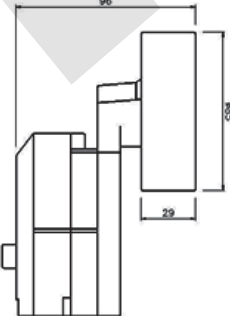

<p>1001</p>  <p>Ø60 X 30 X Ø17</p>		<p>Distribución</p>	<p>0830.48 VKM-23140 F-123906.50</p>	<p>Polea de correa inversion guia</p>	<p>FIESTA 2003/ ECOSPORT Mot.1.4 TDCI</p>	
<p>1002</p>  <p>Ø60 X 30 X Ø10</p>		<p>Poly-V</p>	<p>5751.87 VKM-23044 F-123934</p>	<p>Polea de correa inversion guia</p>	<p>FIESTA 2003/ ECOSPORT Mot.1.4 TDCI Con aire acond.</p>	
<p>1066</p>  <p>Ø51 X 26</p>		<p>Poly-V</p>	<p>5751.88 VKM-33060 F-123933.50</p>	<p>Polea de correa inversion guia</p>	<p>FIESTA 2003/ ECOSPORT Mot.1.4 TDCI Sin aire acond.</p>	
<p>1161</p>  <p>Ø65 X 26 X Ø17</p>		<p>Poly-V</p>	<p>5751.H6 VKM-33164</p>	<p>Polea de correa inversion guia</p>	<p>FOCUS II FIESTA V</p>	
<p>1163</p>  <p>Ø81X30</p>	 <p>VISTA CORTE</p>	<p>Poly-V</p>	<p>377-145-299</p>	<p>Polea tensora ranurada de Accesorios</p>	<p>FOCUS II DIESEL TDCI</p>	

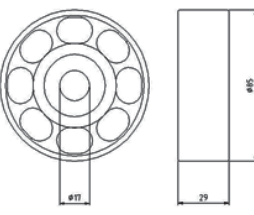

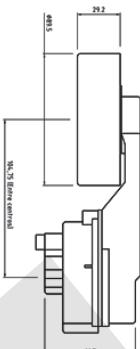

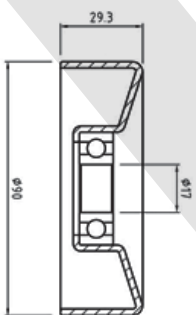

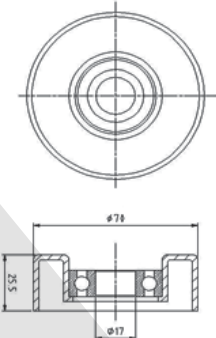

<p>1707</p>  <p>Ø60 X 30 X Ø10</p>		<p>Distribución</p>	<p>6635942 VKM24210 F1400222</p>	<p>Tensor fijo de correa</p>	<p>ESCORT MONDEO FIESTA ORION SIERRA</p>	
<p>1706</p>  <p>Ø60 X 23 X Ø17</p>		<p>Distribución</p>	<p>1052359 ----- -----</p>	<p>Tensor fijo de correa</p>	<p>FIESTA (línea nueva 97 en adelante)</p>	
<p>1704</p>  <p>Ø73,25 X 22,5 X Ø17</p>		<p>Distribución</p>	<p>1053684 VKM24210 -----</p>	<p>Tensor fijo de correa</p>	<p>FIESTA COURIER</p>	
<p>1750</p>  <p>Ø64 X 35 X Ø10</p>		<p>Distribución</p>	<p>Rover-LHV 100150 ----- F-1410070.1</p>	<p>Tensor fijo de correa</p>	<p>MOTOR MAXION F100 '97 RANGER 2.5 2.8 TD / BLAZER S10 HASTA '99 SPRINTER</p>	  
<p>1751</p>  <p>Ø67 X 38</p>		<p>Distribución</p>	<p>Rover-LHP 100680 VKM17046 F-140564.1</p>	<p>Tensor fijo de correa</p>	<p>MOTOR MAXION F100 '97 RANGER 2.5 2.8 TD / BLAZER S10 HASTA '99 SPRINTER</p>	  

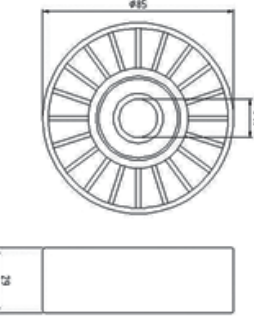
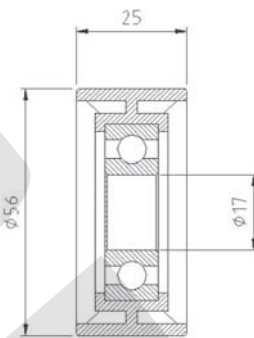
<p>1758</p>  <p>Ø72 X 31 X Ø38</p>		<p>Distribución</p>	<p>70670208 VKM26101 -----</p>	<p>Engranaje fijo de correa de distribución</p>	<p>MOTOR MAXION F100 '97 RANGER 2.5 2.8 TD / BLAZER S10 HASTA '99 SPRINTER</p>	  
<p>1759</p> 		<p>Distribución</p>	<p>----- ----- -----</p>	<p>Kit tensores de correa de distribución</p>	<p>MOTOR MAXION F100 '97 RANGER 2.5 2.8 TD / BLAZER S10 HASTA '99 SPRINTER</p>	  
<p>1812S</p>  <p>Ø56 X 25 X Ø10</p>		<p>Distribución</p>	<p>96FF6k254DA VKM 24100 F-140073.2</p>	<p>Engranaje de correa fijo de distribución.</p>	<p>ESCORT MONDEO FIESTA ORION SIERRA MOTOR 1.8 Dsl.</p>	
<p>1813S</p>  <p>Ø56 X 25 X Ø10</p>		<p>Distribución</p>	<p>97FF 6K254 DC/DD VKM 24107 F-140845</p>	<p>Engranaje de correa fijo de distribución.</p>	<p>ESCORT MONDEO FIESTA ORION SIERRA MOTOR 1.8 Dsl.</p>	
<p>1814</p>  <p>Ø50 X 25 X Ø10</p>		<p>Distribución</p>	<p>97FF 6K254CB VKM 14107 F-234391</p>	<p>Engranaje de correa fijo de distribución.</p>	<p>ESCORT MONDEO FIESTA MOTOR 1.8 Dsl.</p>	

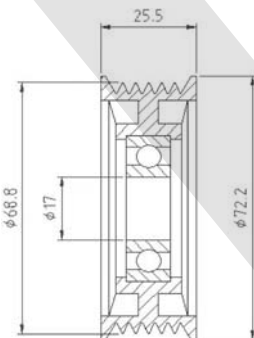
<p>1815</p>  <p>Ø53 X 22</p>		<p>Distribución</p>	<p>89F-6K254 AC /AD VKM 14100 F-140057.1</p>	<p>Tensor de correa de distribución con bordes</p>	<p>COURIER ESCORT FIESTA MONDEO ORION SIERRA</p>	
<p>1816</p>  <p>Ø53 X 27</p>		<p>Distribución</p>	<p>96FF-6K254-AA VKM 14105 F-140057.2</p>	<p>Tensor de correa de distribución sin bordes</p>	<p>COURIER ESCORT FIESTA MONDEO ORION SIERRA</p>	
<p>1839</p>  <p>Ø70 X 24 X Ø8</p>		<p>Distribución</p>	<p>YS4E-19A216AA VKM34034 -----</p>	<p>Tensor fijo correa de distribución</p>	<p>FIESTA '97 Motor Zetec Nafta</p>	
<p>1707N</p>  <p>Ø48 X 30 X Ø10</p>		<p>Distribución</p>	<p>928M6M250DC VKM24211 F-140223</p>	<p>Tensor fijo correa de distribución</p>	<p>Escort Orion Fiesta 1.6-1.8 Focus 1.8-2.0 Mondeo 1.6-1.8 2.0</p>	
<p>1840</p>  <p>Ø86 X 30</p>		<p>Distribución</p>	<p>928M6M254AC VKM14210 F-140221</p>	<p>Tensor de correa</p>	<p>ESCORT FIESTA MONDEO ORION Motor Zetec E 1.8 16 Válv. 2.0 16 Válv. 1.6 Nafta</p>	

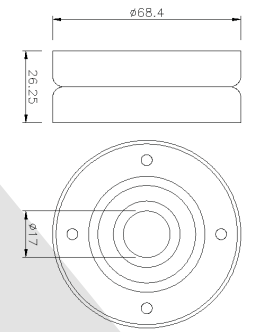
<p>1845</p>  <p>Ø74 X 39</p>		<p>Alternador</p>	<p>3922900 ----- -----</p>	<p>Tensor de correa alternador</p>	<p>CARGO 914 / 915 / 989 F100 / F2000 F 4000 / F14000</p>	
<p>1842</p>  <p>Ø60 X 26</p>		<p>Distribución</p>	<p>1005822/6177882 VKM 14103 F-110937</p>	<p>Tensor de correa</p>	<p>COURIER ESCORT ORION ESCORT FIESTA Motor Kent 1.8d</p>	
<p>1846</p>  <p>Ø72 X 28</p>		<p>Alternador</p>	<p>3936210 ----- -----</p>	<p>Tensor de correa alternador</p>	<p>F100 F4000 F14000</p>	
<p>1851</p>  <p>Ø85 X 29 X Ø17</p>		<p>Distribución</p>	<p>----- VKM 04781A F-236649</p>	<p>Tensor automático de correa</p>	<p>F100 - Ranger (Motor maxion 2.5 / 2.8 dsl.) Sprinter (Motor maxion 2.5) Pick up D20-Blazer Silverado-S10 (Motor maxion 2.5 dsl.)</p>	

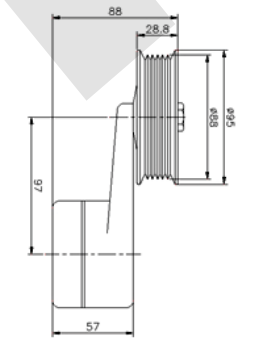
<p>1850</p>  <p>Ø85 X 29 X Ø17</p>		<p>Distribución</p>	<p>---- VKM 04781A ----</p>	<p>Polea tensora</p>	<p>F100 - Ranger (Motor maxion 2.5 / 2.8 dsl.) Sprinter (Motor maxion 2.5) Pick up D20-Blazer Silverado-S10 (Motor maxion 2.5 dsl.)</p>	
<p>1844</p>  <p>Ø90 X 29</p>		<p>Poly-V</p>	<p>70810066 ----- -----</p>	<p>Tensor automático de correa</p>	<p>Ranger 2005 International 3.0TD</p>	
<p>1854</p>  <p>Ø90 X 29 X Ø17</p>		<p>Poly-V</p>	<p>---- ----- -----</p>	<p>Polea tensora</p>	<p>Ranger 2005 International 3.0TD</p>	
<p>1853</p>  <p>Ø70 X 25 X Ø17</p>		<p>Poly-V</p>	<p>---- VKM 34034 -----</p>	<p>Tensor automático de correa</p>	<p>FORD KA (Motor Endura 1.3 Motor Zetec Rocm) FOCUS</p>	







<p>1232</p>  <p>Ø85 X 29 X Ø17</p>		<p>Poly-V</p>	<p>----</p> <p>-----</p> <p>-----</p>	<p>Polea tensora (Alternador)</p>	<p>F-100 (MOTOR MAXION)</p>	
<p>1233</p>  <p>Ø56 X 25 X Ø17</p>		<p>Poly-V</p>	<p>----</p> <p>-----</p> <p>-----</p>	<p>Polea tensora (Alternador)</p>	<p>ECOSPORT FIESTA 1.4 DSL.</p>	
<p>1855</p>  <p>Ø69X 26 X Ø17</p>		<p>Poly-V</p>	<p>1073096</p> <p>-----</p> <p>-----</p>	<p>Polea tensora (Rep. Poly-V)</p>	<p>FOCUS MONDEO RANGER KA / ECOSPORT EXPLORER</p>	
<p>1841</p>  <p>Ø68 X 26 X Ø17</p>		<p>Distribución</p>	<p>90411025/ 90500229/ 1340541</p> <p>----</p> <p>-----</p>	<p>Tensor fijo de correa</p>	<p>CORSA 1.6 CORSA todos con AA/VECTRA ASTRA 2.0 / S10 Motor MWM ESCORT DSL. GOL 1.9 GOLF TDI</p>	  
<p>1817</p>  <p>Ø88 X 28</p>		<p>Poly-V</p>	<p>9607034100</p> <p>-----</p> <p>-----</p>	<p>Tensor automático de correa poli-V</p>	<p>MOTOR MWM 6 Cilindros SILVERADO F100</p>	 

Catálogo Tensores de Correa

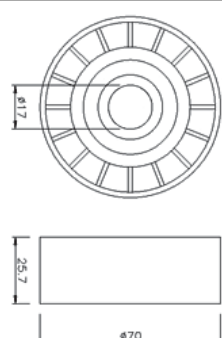

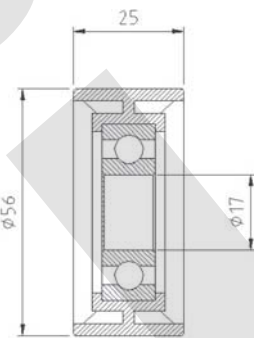

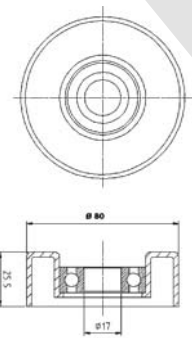

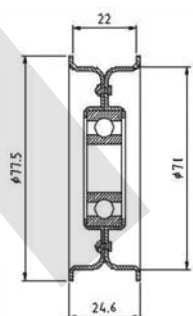

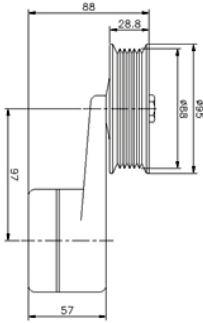

NeoTek

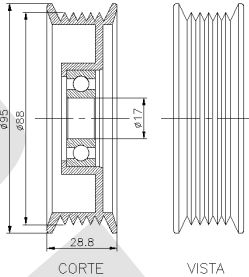

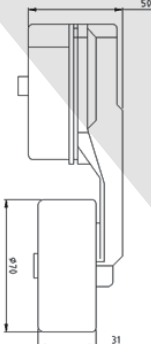

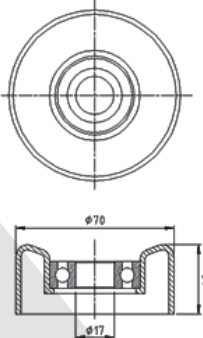

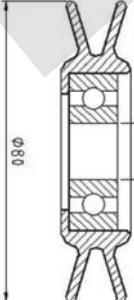



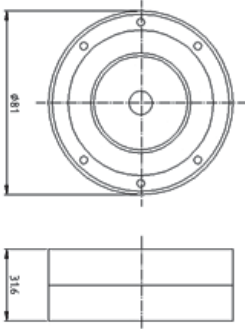

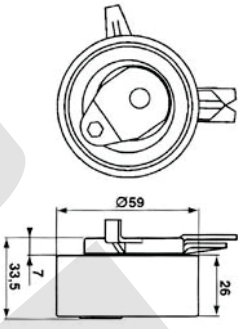

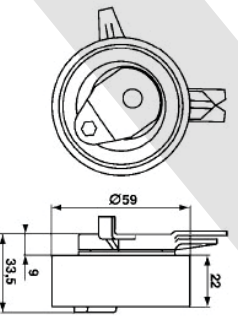

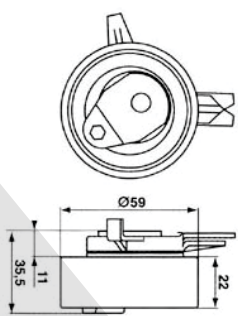

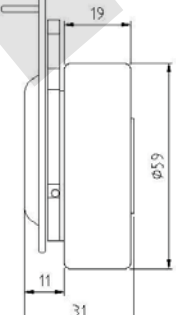

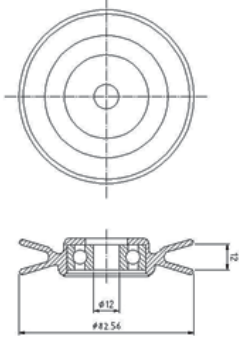

distribuidora rio

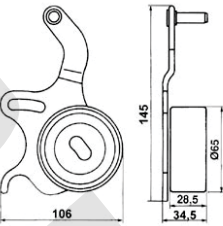

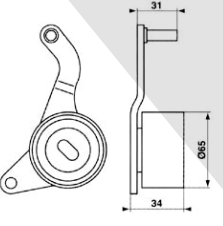

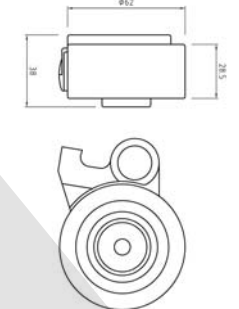

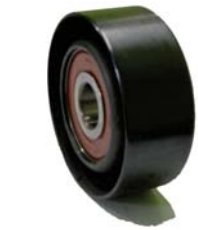
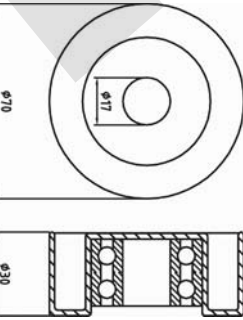



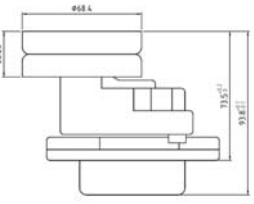

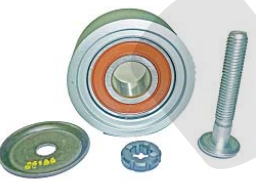
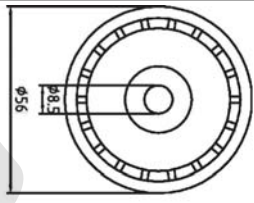

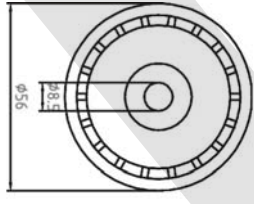

Código/Imágen	Plano/Medidas	Correa	Códigos Original/SKF/INA	Descripción del artículo	Aplicación	Marca
<p>2326</p>  <p>Ø70 X 26 X Ø17</p>		Poly-V	90411025 VKM33013	Tensor de correa Aire acondic.	CORSA ASTRA VECTRA	
<p>2330</p>  <p>Ø56 X 25 X Ø17</p>		Poly-V	VKM33061R	Polea tensora de aire acond. y alternador	CORSA II MERIVA 1.8	
<p>5008</p>  <p>Ø80 X 25 X Ø17</p>		Poly-V	---	Polea tensora de correa	FIT	
<p>2327</p>  <p>Ø70 X 22 X Ø17</p>		Poly-V	93374496 ---	Tensor de correa alternador	CORSA CORSA II ASTRA ZAFIRA MERIVA	



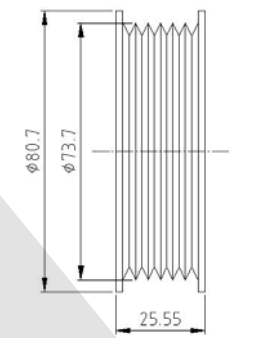

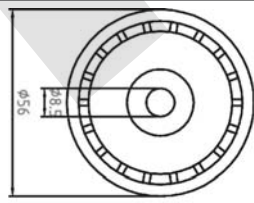

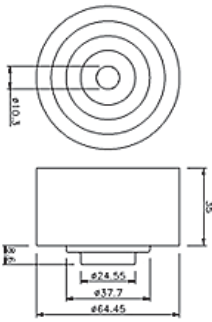

<p>2134</p>  <p>Ø68 X 26X Ø17</p>		<p>Distribución</p>	<p>90411025/ 90500229/ 1340541 --- ---</p>	<p>Tensor fijo de correa</p>	<p>CORSA 1.6 CORSA todos con AA/VECTRA ASTRA 2.0 / S10 Motor MWM ESCORT DSL. GOL 1.9 GOLF TDI</p>	
<p>2276</p>  <p>Ø54 X 22 X Ø8</p>		<p>Distribución</p>	<p>09 126 740 VKM 25150 F-224967</p>	<p>Tensor fijo de correa de distribución.</p>	<p>CORSA VECTRA ASTRA 1.4 -1.6 -1.8 -16 Válvulas y 1.5 Dsl.</p>	
<p>2277</p>  <p>Ø64 X 22 X Ø8</p>		<p>Distribución</p>	<p>09 128 739 VKM 25152 F-224971</p>	<p>Tensor fijo de correa de distribución</p>	<p>CORSA VECTRA ASTRA 1.4 -1.6 -1.8 -16 Válvulas y 1.5 Dsl.</p>	
<p>2278</p>  <p>Ø64 X 27 X Ø8</p>		<p>Distribución</p>	<p>09 128 738 VKM 25212 F-224964</p>	<p>Tensor fijo de correa de distribución.</p>	<p>VECTRA ASTRA 2.0 - 2.2 - 16 Válvulas</p>	
<p>2279</p>  <p>Ø64 X 27 X Ø8</p>		<p>Distribución</p>	<p>90 411 773 VKM 25213 F-224966</p>	<p>Tensor fijo de correa de distribución</p>	<p>VECTRA ASTRA 2.0 - 2.2 - 16 Válvulas</p>	

<p>2299</p>  <p>Ø88 X 28</p>		<p>Poly-V</p>	<p>9607034100 ----- -----</p>	<p>Tensor automático de correa poli-V</p>	<p>MOTOR MWM 6 Cilindros SILVERADO F100</p>	
<p>2300</p>  <p>Ø88 X 28</p>		<p>Poly-V</p>	<p>9607034100 ----- -----</p>	<p>Polea de Tensor automático correa poli-V</p>	<p>MOTOR MWM 6 Cilindros SILVERADO F100</p>	
<p>2280</p>  <p>Ø70 X 31 X Ø17</p>		<p>Poly-V</p>	<p>940703410074 ----- -----</p>	<p>Tensor automático de correa</p>	<p>Blazer S10. Motor MWM 2.8 DDI F100</p>	
<p>2280-1</p>  <p>Ø70 X 31 X Ø17</p>		<p>Poly-V</p>	<p>----- ----- -----</p>	<p>Polea Tensora</p>	<p>Blazer S10. Motor MWM 2.8 DDI</p>	
<p>2328</p>  <p>Ø80 X 19 X Ø15</p>		<p>Alternador</p>	<p>----- ----- -----</p>	<p>Polea unidireccional</p>	<p>Comb. 1,7 D. Corsa 1,7 D.</p>	

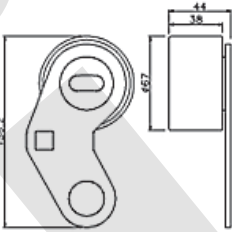
<p>2301</p>  <p>Ø81 X 32</p>		<p>Distribución</p>	<p>----- VKM 26501 F-123142</p>	<p>Tensor</p>	<p>PICKUP D 20 SILVERADO S10 BLAZER</p>	
<p>2296</p>  <p>Ø59 X 26</p>		<p>Distribución</p>	<p>636737 VKM15202 F-232488</p>	<p>Tensor</p>	<p>Astra Vectra 2.0 16V</p>	
<p>2297</p>  <p>Ø59 X 22</p>		<p>Distribución</p>	<p>90530124 VKM15402 F-234394</p>	<p>Tensor</p>	<p>Astra Vectra 1.8 2.0</p>	
<p>2292</p>  <p>Ø59 X 22</p>		<p>Distribución</p>	<p>636739 VKM15214 F-232481</p>	<p>Tensor</p>	<p>Corsa 1.4 / 1.6</p>	
<p>2293</p>  <p>Ø59 X 19</p>		<p>Distribución</p>	<p>636734 VKM15121 F-232482</p>	<p>Tensor de dirección</p>	<p>Corsa Corsa combo Tigra 1.6 Naf. Blazer 2.2 nafta</p>	

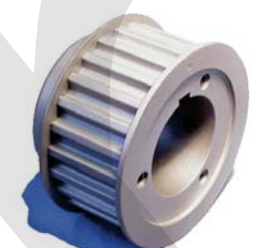
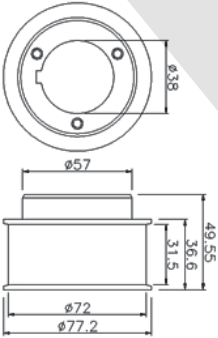
<p>5401</p>  <p>Ø82 X 16 X Ø12</p>		<p>Alternador</p>	<p>----- ----- -----</p>	<p>Polea tensora</p>	<p>Hylux</p>	
<p>2294</p>  <p>Ø65 X 28</p>		<p>Distribución</p>	<p>97010530 VKM15213 F-123806</p>	<p>Tensor de correa de distribución</p>	<p>Astra Corsa Vectra 1.7 td 92-94</p>	
<p>2295</p>  <p>Ø65 X 28</p>		<p>Distribución</p>	<p>97114552 VKM15215 F-123815</p>	<p>Tensor de correa de distribución</p>	<p>Astra 1.7 td 94-98 Corsa 1.7 96-99 Vectra 1.7 td 96</p>	
<p>5402</p>  <p>Ø62 X 28</p>		<p>Distribución</p>	<p>13505 / 67040 VKM71014 -----</p>	<p>Tensor de correa de distribución</p>	<p>Hilux Landcruiser 3.0 DSL</p>	
<p>5403</p>  <p>Ø74 X 30 X Ø17</p>		<p>Poly-V</p>	<p>----- VKM61020 -----</p>	<p>Rep. Polea tensora</p>	<p>HILUX II 82 05 Y HILUX III</p>	

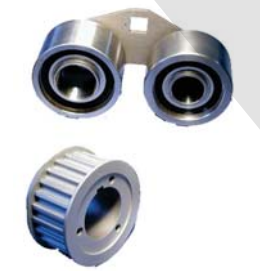
<p>2313</p>  <p>Ø68 X 26</p>		<p>Poly-V</p>	<p>24412292/13 VKM35009 F-235783</p>	<p>Tensor automatico de correa</p>	<p>Astra (1.4-1.6-2.0) Corsa Meriva Tigra Vectra (1.8 - 2.0)</p>	
<p>2332C</p>  <p>Ø56 X 25 X Ø17</p>	 <p>NUEVO PRODUCTO</p> 	<p>Alternador</p>	<p>552013640 93302612 VKM 04754A .----</p>	<p>Tensor metálico de alternador (Completo)</p>	<p>Corsa 1.8 Meriva Stilo Idea Punto 1.8</p>	 
<p>2332</p>  <p>Ø56 X 25 X Ø17</p>	 	<p>Alternador</p>	<p>552013640 93302612 VKM 04754A .----</p>	<p>Tensor metálico de alternador</p>	<p>Corsa 1.8 Meriva Stilo Idea Punto 1.8</p>	 
<p>2331C</p>  <p>Ø74 X 25 X Ø17</p>		<p>Poly-V</p>	<p>GM 94702967 ----- -----</p>	<p>Polea con complementos</p>	<p>CORSA 1.4 1.0 8V AGILE 1.4 8V CELTA 1.0 8V PRISMA 1.0 1.4 8V</p>	
<p>2332P</p>  <p>Ø56 X 25 X Ø8</p>	 <p>NUEVO PRODUCTO</p> 	<p>Alternador</p>	<p>552013640 93302612 VKM 04754A</p>	<p>Tensor plástico de alternador Con buje</p>	<p>Corsa 1.8 Meriva Stilo Idea Punto 1.8</p>	 

<p>2302</p>  <p>Ø64 X 35 X Ø10</p>		<p>Distribución</p>	<p>Rover-LHV 100150 ----- F-1410070.1</p>	<p>Tensor fijo de correa</p>	<p>MOTOR MAXION F100 '97 RANGER 2.5 2.8 TD / BLAZER S10 HASTA '99 SPRINTER</p>	
<p>2303</p>  <p>Ø67 X 38</p>		<p>Distribución</p>	<p>Rover-LHP 100680 VKM17046 F-140564.1</p>	<p>Tensor fijo de correa</p>	<p>MOTOR MAXION F100 '97 RANGER 2.5 2.8 TD / BLAZER S10 HASTA '99 SPRINTER</p>	
<p>2304</p>  <p>Ø72 X 31 X Ø38</p>		<p>Distribución</p>	<p>70670208 VKM26101 -----</p>	<p>Engranaje fino de correa de distribución</p>		
<p>2305</p> 		<p>Distribución</p>	<p>----- ----- -----</p>	<p>Kit tensores de correa de distribución</p>	<p>MOTOR MAXION F100 '97 RANGER 2.5 2.8 TD / BLAZER S10 HASTA '99 SPRINTER</p>	









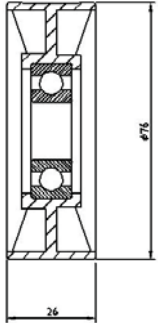

Catálogo Tensores de Correa

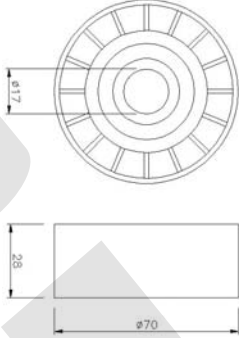

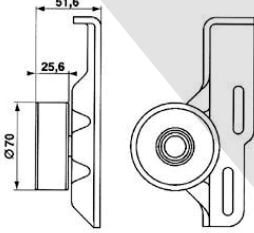

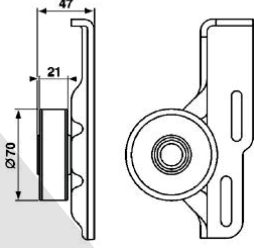

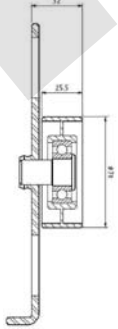

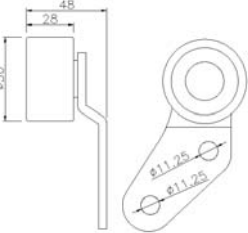

NeoTek

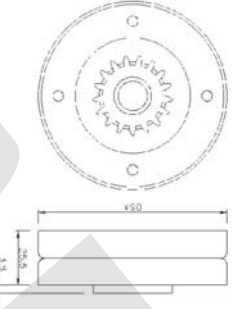

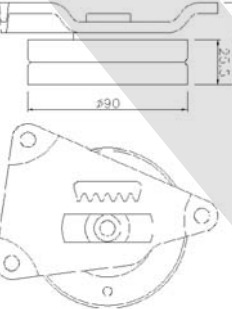

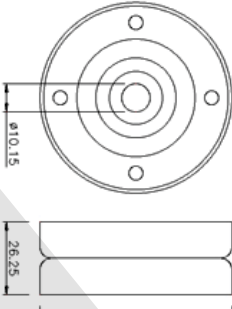

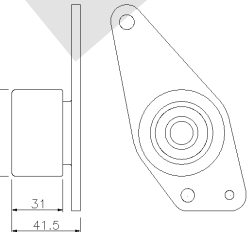



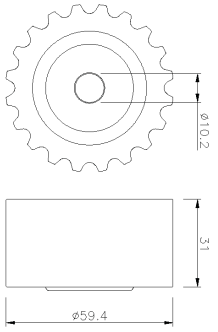

distribuidora rio

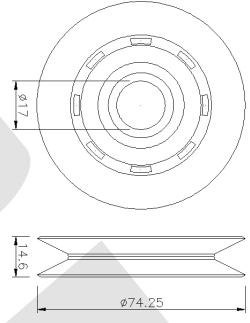

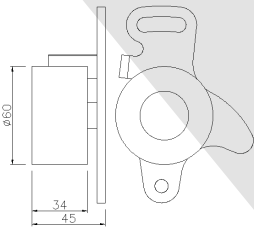

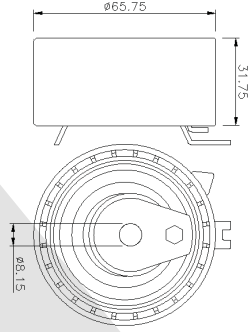



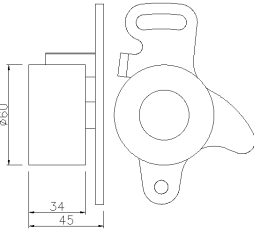

Código/Imágen	Plano/Medidas	Correa	Códigos Original/SKF/INA	Descripción del artículo	Aplicación	Marca
3249 	<p>NUEVO PRODUCTO</p>	Poly-V	7700102872 VKM 36020	Polea tensora Correa Poly V	Clio II 1.4 / 1.6 Kangoo 1.4 / 1.6 Megane 1.6 / 2.0 Laguna 1.6 / 1.8	
3250 	<p>NUEVO PRODUCTO</p>	Poly-V	8200048486 VKM 36050 F-5310590.30	Polea tensora correa Poly-V	Clio II 1.5 Megane II 1.5/1.6 Grand Scenic 1.5 / 1.6	
3239  <p>Ø55 X 22</p>		Distribución	7700273277 VKM 16001 F-123154.3	Polea tensora distribución	Clio/ClioII Kangoo Twingo Megane motores EFJ 1.4 K7m 1.6	
3240  <p>Ø56 X 21 X Ø17</p>		Poly-V	8200040161 VKM 36025 F-122676.11	Polea tensora alternador	CLIO II KANGOO TWINGO	

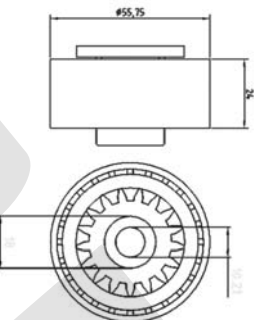

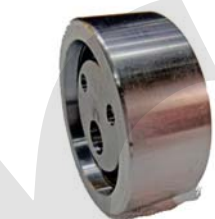
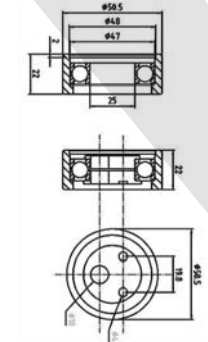

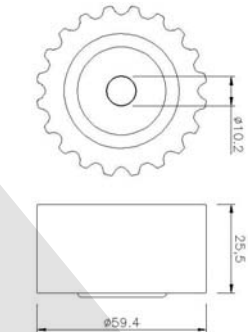

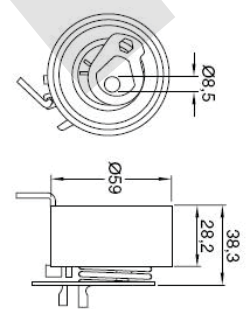

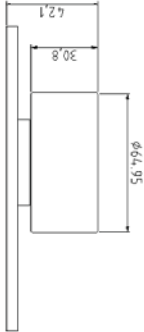

<p>3241</p>  <p>Ø76 X 26 X Ø17</p>		<p>Poly-V</p>	<p>----- ----- -----</p>	<p>Polea tensora</p>	<p>Laguna</p>	
<p>3242</p>  <p>Ø70 X 28 X Ø17</p>		<p>Poly-V</p>	<p>----- ----- -----</p>	<p>Polea tensora</p>	<p>Kangoo (AIRE - ALTERNADOR)</p>	
<p>3234</p>  <p>Ø70 X 26</p>		<p>Distribución</p>	<p>7700862108 VKM 36010 F-123146</p>	<p>Tensor de correa</p>	<p>Megane RT RXE / RT TD Coupe Cabriolet Scenic 1.6 nafta</p>	
<p>3235</p>  <p>Ø70 X 21</p>		<p>Distribución</p>	<p>7700272972 VKM 36005 F-123147</p>	<p>Tensor de correa</p>	<p>Megane RT RXE / RT TD Coupe Cabriolet Scenic 1.6 nafta</p>	
<p>3236</p>  <p>Ø70 X 25</p>		<p>Poly-V</p>	<p>7700105525 ----- F-123775</p>	<p>Tensor de correa</p>	<p>Megane 1.6</p>	

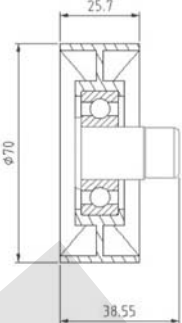

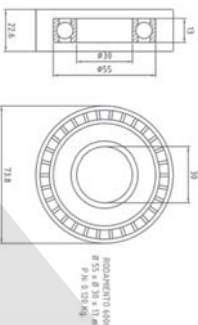

<p>3087</p>  <p>Ø50 X 28</p>		<p>Poly-V</p>	<p>7700271618 VKM 36014 F-121586</p>	<p>Tensor fijo correa de accesorio</p>	<p>R19 Motor 1.9 Diesel</p>	
<p>3088</p>  <p>Ø90 X 26</p>		<p>Poly-V</p>	<p>7700852410 VKM 36012 F-121271.1</p>	<p>Polea tensora circuito aux. con cremallera</p>	<p>R9 / R11 / R19 MEGANE Motor 1.6 C3L 1.9 Diesel</p>	
<p>3223</p>  <p>Ø90 X 26</p>		<p>Poly-V</p>	<p>7700852410 VKM 36012 F-121271.1</p>	<p>Polea tensora circuito aux. con cremallera</p>	<p>R9 / R11 / R19 MEGANE Motor 1.6 C3L 1.9 Diesel</p>	
<p>3089</p>  <p>Ø68 X 30 X Ø10</p>		<p>Poly-V</p>	<p>7700735603 VKM 36013 F-120850</p>	<p>Polea fija de correa circuito auxiliar con AA</p>	<p>R9 / R11 R19 / R21 Clio Motor C3L</p>	
<p>3090</p>  <p>Ø50 X 31</p>		<p>Distribución</p>	<p>7700733486 VKM 26101 F-123132</p>	<p>Polea fija de correa circuito auxiliar con AA</p>	<p>R9 / R11 / R19 R21 / TRAFIC CLIO / EXPRESS LAGUNA MEGANE</p>	

<p>3091</p>  <p>Ø50 X 31</p>		<p>Distribución</p>	<p>7700736489 VKM 26102 F-39990</p>	<p>Polea fija de correa de distribución.</p>	<p>CLIO EXPRESS KANGOO MEGANE R19 / R21</p>	
<p>3209</p>  <p>Ø52 X 31</p>		<p>Distribución</p>	<p>7700736419 VKM 16112 F-120180</p>	<p>Tensor de correa de distribución.</p>	<p>CLIO MEGANE R19</p>	
<p>3210</p>  <p>Ø52 X 31</p>		<p>Distribución</p>	<p>7700863113 VKM 16101 F-123776</p>	<p>Tensor de correa de distribución.</p>	<p>CLIO EXPRESS KANGOO MEGANE TRAFIC R9 / R11 R19 / R21</p>	
<p>3224</p>  <p>Ø52 X 31</p>		<p>Distribución</p>	<p>7700100671 VKM 16101.1 F-29508.5</p>	<p>Tensor de correa de distribución.</p>	<p>CLIO EXPRESS KANGOO MEGANE TRAFIC R9 / R11 R19 / R21</p>	
<p>3212</p>  <p>Ø65 X 31</p>		<p>Distribución</p>	<p>8200045735 VKM 26115 F-123779</p>	<p>Tensor fijo de correa de distribución</p>	<p>CLIO KANGOO LAGUNA MEGANE Motor 1.9 DTi</p>	

<p>3225</p> 		<p>Distribución</p>	<p>7700107249 VKM 26125 F-123777</p>	<p>Tensor fijo de correa de distribución</p>	<p>CLIO KANGOO LAGUNA MEGANE Motor 1.9 DTi</p>	
<p>3226</p>  <p>Ø74 X 15 XØ17</p>		<p>Alternador</p>	<p>7702089333 ----- -----</p>	<p>Tensor fijo de correa alternador-AA</p>	<p>R9 / R11 / R19</p>	
<p>3227</p>  <p>Ø60 X 34</p>		<p>Distribución</p>	<p>7700722452 VKM 16210 F-37630.1</p>	<p>Tensor de correa de distribución.</p>	<p>R18 / R21 TRAFIC Motor 2.1 Dsl-TDsl.</p>	
<p>3228</p>  <p>Ø66 X 32 XØ8</p>		<p>Distribución</p>	<p>8200347761 VKM 16020 F-550228</p>	<p>Tensor automático correa de distribución.</p>	<p>CLIO / MEGANE KANGOO LAGUNA SCENIC Motor 1.4 y 1.6 16 Válvulas</p>	
<p>3229</p>  <p>Ø54 X 32 XØ10</p>	<p>NUEVO PRODUCTO</p> 	<p>Distribución</p>	<p>7700107150 VKM 26020 F-123778</p>	<p>Tensor fijo de correa de distribución. 2 RODAMIENTOS</p>	<p>CLIO / MEGANE KANGOO LAGUNA SCENIC Mod. 2003 Motor 1.6 16 Vál.</p>	

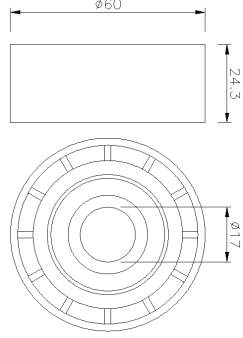
<p>3237</p>  <p>Ø60 X 28</p>		<p>Distribución</p>	<p>7700692315 VKM 16200 F-37629</p>	<p>Tensor de correa.</p>	<p>18 / 21 Trafic 2.2 Nafta</p>	
<p>3213</p>  <p>Ø56 X 24</p>		<p>Poly-V</p>	<p>7700868201 VKM 36023 F-123148</p>	<p>Tensor de correa circuito AA</p>	<p>TWINGO Motor 1.2</p>	
<p>3238</p>  <p>Ø50 X 22</p>		<p>Distribución</p>	<p>7700736085 VKM 16000 F 39924.10</p>	<p>Polea tensora distribución</p>	<p>Clio 1.2 1.4 Clio II Twingo1.2 Express Megane1.4 1.6 Kangoo1.2 R19 1.2 1.4</p>	
<p>3233</p>  <p>Ø60 X 26 X Ø10</p>		<p>Distribución</p>	<p>7700875305 VKM 26123 F-123732</p>	<p>Tensor fijo de correa</p>	<p>Megane</p>	
<p>3231</p>  <p>Ø59 X 28</p>		<p>Distribución</p>	<p>8200035827 VKM 16002 F-1236389</p>	<p>Tensor automático de correa</p>	<p>CLIO II TWINGO KANGOO MOTOR 1.2 16 V</p>	

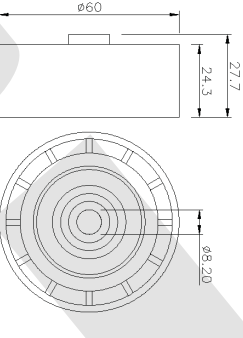
<p>3230</p>  <p>Ø65 X 31</p>		<p>Distribución</p>	<p>----- VKM 26128 -----</p>	<p>Tensor de correa</p>	<p>Clio II Kangoo Laguna Master II Megane Scenic Motor 1.9 dti f9q</p>	
<p>3243</p>  <p>Ø70 X 26</p>		<p>Distribución</p>	<p>----- VKM 36005R -----</p>	<p>Polea tensora distribución</p>	<p>MEGANE RT RXE RT TD - COUPE CABRIOLET SCENIC (MOTOR 1.6 NAFTA)</p>	
<p>3244</p>  <p>Ø60 X 31 X Ø17</p>		<p>Distribución</p>	<p>----- VKM 36040 532 0364 20</p>	<p>Polea tensora distribución</p>	<p>Trafic II 2.5 DCI Laguna II 2.2DCI master</p>	
<p>3247</p>  <p>Ø73 X 22</p>		<p>Distribución</p>	<p>8200908180 VKM 16009 -----</p>	<p>Polea tensora distribución</p>	<p>LOGAN SANDERO KANGOO</p>	
<p>3248</p>  <p>Ø127 X 22</p>		<p>Poly-V</p>	<p>8200641468 8200170009 8200171807 VKM 36053 -----</p>	<p>Polea inversión guía</p>	<p>CLIO II KANGOO FURGON MEGANE II BERLINA SCENIC II KANGOO EXPRESS</p>	

<p>3232</p>  <p>Ø60 X 25 X Ø17</p>		<p>Poly-V</p>	<p>7700102931 VKM 36031 F-124059</p>	<p>Tensor fijo de correa</p>	<p>Partner/Clio ClioII/kangoo LagunaII/Megane RT-RXE-RT TD Coupe Cabriolet/Scenic Berlingo/Spazio3</p>	
<p>3232-1</p>  <p>Ø60 X 26 X Ø17</p>		<p>Poly-V</p>	<p>7700102931 VKM 36031 F-124059</p>	<p>Tensor fijo de correa</p>	<p>Partner/Clio ClioII/kangoo LagunaII Megane RT-RXE-RT TD Coupe/Cabriolet Scenic/Berlingo Spazio3</p>	

Catálogo Tensores de Correa

NeoTek













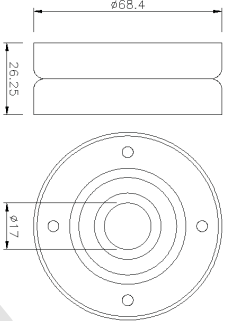

Código/Imagen	Plano/Medidas	Correa	Códigos Original/SKF/INA	Descripción del artículo	Aplicación	Marca
<p>4277</p>  <p>Ø76 X 24 X Ø17</p>	<p>NUEVO PRODUCTO</p>	<p>Poly-V</p>	<p>036-145299 INA F-567276</p>	<p>Polea tensora de correa</p>	<p>Gol Trend Gol AT 1.0 8 y 16 Valvulas Con dir.ldr.</p>	

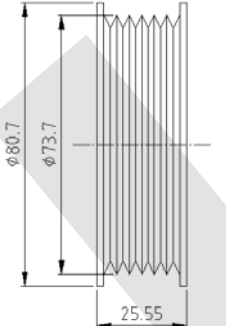



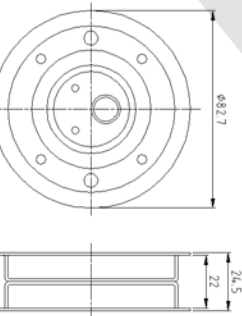

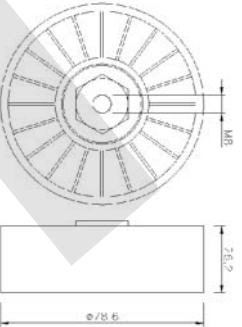

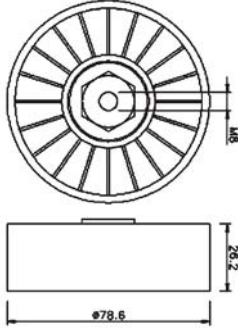

Catálogo Tensores de Correa

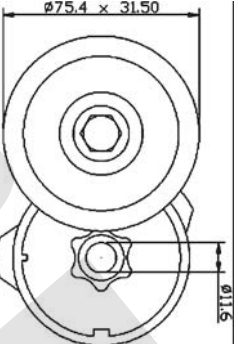

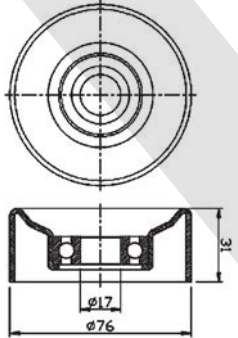

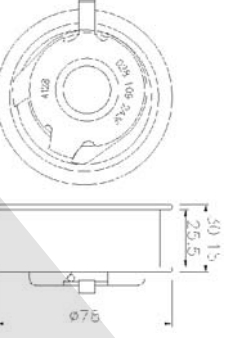

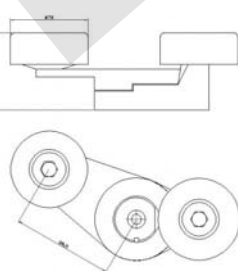

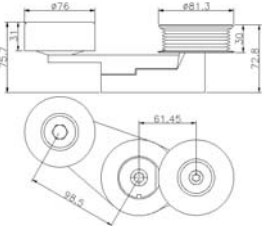

NeoTek

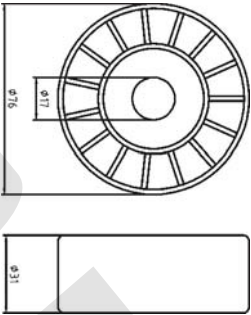

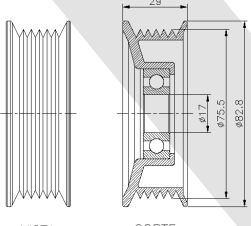



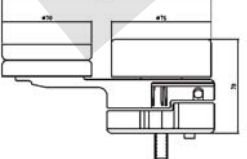



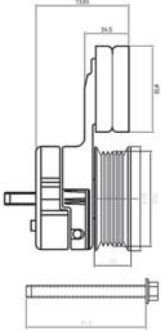

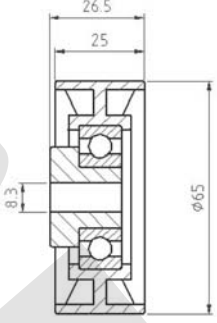
distribuidora rio

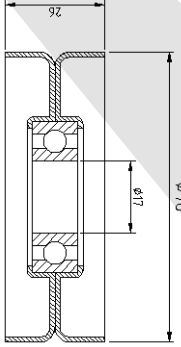
Código/Imágen	Plano/Medidas	Correa	Códigos Original/SKF/INA	Descripción del artículo	Aplicación	Marca
<p>4242</p>  <p>Ø68 X 26 X Ø17</p>		Distribución	90411025/ 90500229/ 1340541 --- ---	Tensor fijo de correa	CORSA 1.6 CORSA todos con AA/VECTRA ASTRA 2.0 / S10 Motor MWM ESCORT DSL. GOL 1.9 GOLF TDI	  
<p>4243</p>  <p>Ø74 X 25 X Ø17</p>		Poly-V	---	Polea tensora	Pointer Orion	 
<p>4229</p>  <p>Ø82 X 22</p>		Distribución	026-109243 VKM 11000 F-214797	Tensor de correa de distribución	GOL / SAVEIRO SENDA /GACEL (1.6 / 1.8 / 2.0 NAF.) VW CADDY 1.8 NAF. CARAT 1.6 NAF. - POLO 1.6 1.8 NAF. QUANTUM 1.8 / 2.0 NAF. ESCORT / ORION 1.6 1.8 NAF. GALAXY 2.0 NAF.	
<p>4160</p>  <p>Ø79 X 26 X Ø8</p>		Poly-V	028-145278-E --- ---	Tensor fijo de correa	POLO 1.9 Motor Diesel	

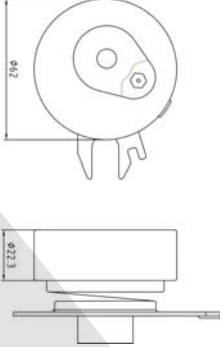
<p>4160</p>  <p>Ø79 X 26 XØ8</p>		<p>Poly-V</p>	<p>028-145278-E VKM 31004 ----</p>	<p>Tensor fijo de correa</p>	<p>POLO 1.6 N 1.9 Diesel Caddy 1.6/1.8 2.0-2.0 16 Val 1.9 TD/Passat 1.8/2.0/1.9 TDI Golf 1.6/1.8/2.0-2.0 16 Val/1.9 TD</p>	
<p>4224</p>  <p>Ø76 X 31 XØ17</p>		<p>Poly-V</p>	<p>068-145299-R5 ---- ----</p>	<p>Tensor automático correa de distribución</p>	<p>Gol 1.6 Dsl. Saveiro 2000 en adelante</p>	
<p>4230</p>  <p>Ø76 X 31 XØ17</p>		<p>Poly-V</p>	<p>377-145-299 ---- ----</p>	<p>Polea lisa de tensor automático correa DH/AA</p>	<p>AB9-Quantum Gol 3º generac. C/DH 99 AD S/AA P.lisa/P.ranurada C./AA 2 poleas lisas. Motor Audi Nafta Todos</p>	
<p>4231</p>  <p>Ø78 X 25</p>		<p>Distribución</p>	<p>028-145278-E VKM 11014 F-232486</p>	<p>Tensor automático correa de distribución.</p>	<p>CADDY / GOLF PASSAT POLO TRANSPORTER SEAT IBIZA CORDOBA</p>	
<p>4232</p>  <p>Ø75 X 26 XØ17</p>		<p>Poly-V</p>	<p>377-260-299 ----- -----</p>	<p>Tensor automático correa DH/AA</p>	<p>AB9-Quantum-Saveiro 97 Nafta 1.6-1.8.2.0 c/AA 2 poleas lisas. Motor Audi Nafta todos.</p>	

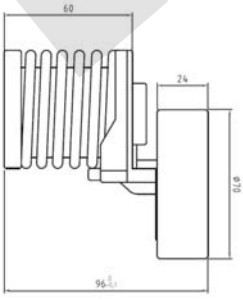
<p>4233</p>  <p>Ø76 X 31 X Ø17</p>		<p>Poly-V</p>	<p>377-145-299 ----- -----</p>	<p>Tensor automático correa DH/AA</p>	<p>AB9-Quantum-Saveiro 97 Nafta 1.6-1.8.2.0 s/AA 1 polea lisa, 1 multicanal. Motor Audi Nafta todos.</p>	
<p>4230</p> 		<p>Poly-V</p>	<p>377-260-299 ----- -----</p>	<p>Polea lisa de tensor automático correa DH/AA</p>	<p>AB9-Quantum-Gol 3º generación C/DH 99 AD S/AA / P.lisa P.ranurada.C/AA 2 poleas lisas. Motor Audi Nafta todos.</p>	
<p>4234</p> 	 <p>VISTA CORTE</p>	<p>Poly-V</p>	<p>377-145-299 ----- -----</p>	<p>Polea ran. de tensor automático correa DH/AA</p>	<p>AB9-Quantum-Gol 3º generación C/DH 99 AD S/AA / P.lisa P.ranurada.C/AA 2 poleas lisas. Motor Audi Nafta todos.</p>	
<p>4276</p>  <p>Ø70 X 24 X Ø17</p>	<p>NUEVO PRODUCTO</p>	<p>Poly-V</p>	<p>0321-45299-A INA F-567275</p>	<p>Polea tensora de correa</p>	<p>GOL GOLF POLO AUDI</p>	
<p>4241</p>  <p>Ø76 X 30</p>		<p>Distribución</p>	<p>028260299.2 ----- -----</p>	<p>Tensor de distribución (2 Poleas lisas)</p>	<p>Gol 1.9 dsl.</p>	











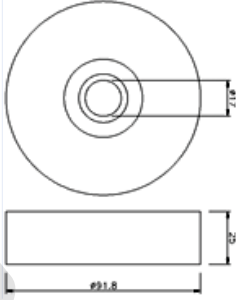

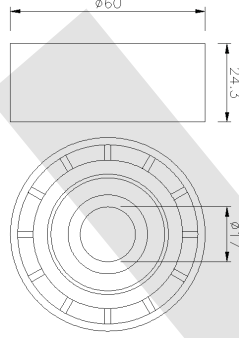
<p>4241-1</p> 		<p>Distribución</p>	<p>----- ----- -----</p>	<p>Tensor de distribución (1 Polea lisa / 1 ranurada)</p>	<p>Gol 1.9 dsl.</p>	
<p>4246</p>  <p>Ø65 X 25 X Ø8</p>		<p>Distribución</p>	<p>038 145276 VKM 31002 -----</p>	<p>Polea tensora distribución</p>	<p>Golf Bora 1.9 TDI Vento 1.9 TDI-SDI Beetle 1.9 TDI.</p>	
<p>4247</p>  <p>Ø76 X 26</p>		<p>Distribución</p>	<p>032 145 276 VKM 31207 -----</p>	<p>Polea tensora</p>	<p>Polo classic 1.0 - 1.6 16V / Fox Suran 1.0 - 1.6 Laguna 2.0 16V</p>	
<p>4248</p>  <p>Ø61 X 22</p>		<p>Distribución</p>	<p>303109243L VKM 11107 -----</p>	<p>Polea distribución</p>	<p>Golf Polo Fox 1.6 8v16v Gol 1.6 8v EA11Gol 1.0 8v</p>	
<p>4189</p>  <p>Ø70 X 24</p>		<p>Poly-V</p>	<p>038 903 315 AH ----- -----</p>	<p>Tensor automático auxiliar</p>	<p>Amarok(todas) Scirocco 2.0-2007/13 Sharan 2.0-2012/13 Tiguan 2.0-1008/13 Vento 2.0-2005/13 Variant 2.0-2008/13</p>	

Catálogo Tensores de Correa

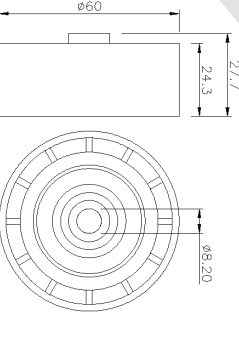



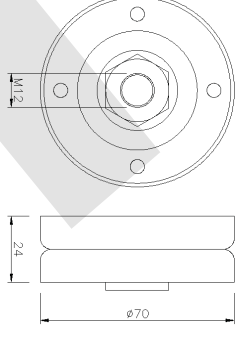





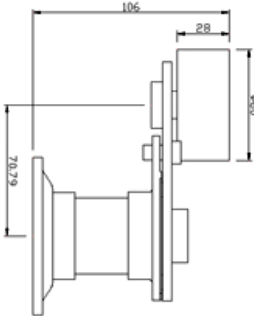

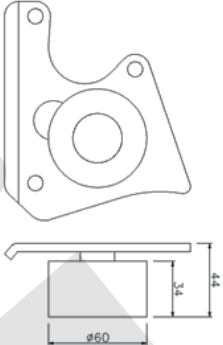

NeoTek



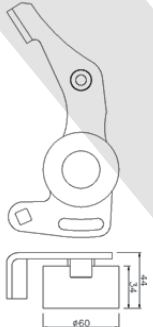



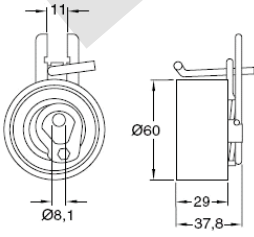



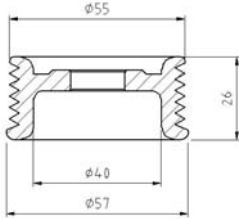

distribuidora rio

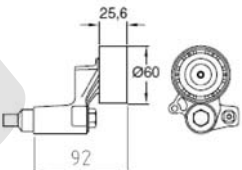
Código/Imágen	Plano/Medidas	Correa	Códigos Original/SKF/INA	Descripción del artículo	Aplicación	Marca
<p>5327</p>  <p>Ø70 X 26 X Ø17</p>		Poly-V	5751200 --- ---	Tensor fijo de correa	405 / 306	
<p>5328</p>  <p>Ø60 X 25 X Ø17</p>		Poly-V	7700102931 VKM 36031 F-124059	Tensor fijo de correa	Partner/Clio ClioII/kangoo LagunaII/Megane RT-RXE-RT TD Coupe Cabriolet/Scenic Berlingo/Spazio3	  
<p>5329</p>  <p>Ø60 X 24 X Ø8</p>		Poly-V	7700102931 VKM 36031 F-124059	Tensor fijo de correa	Partner/Clio ClioII/kangoo LagunaII Megane RT-RXE-RT TD Coupe/Cabriolet Scenic/Berlingo Spazio3	  
<p>5330</p>  <p>Ø70 X 24 X Ø12</p>		Poly-V	5751.14 VKM 33006 F-121373.1	Tensor fijo de correa	405 TD / 205	

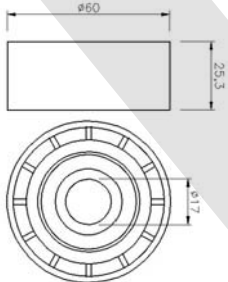

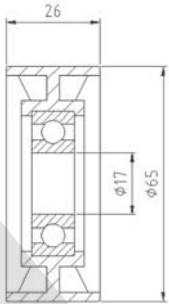

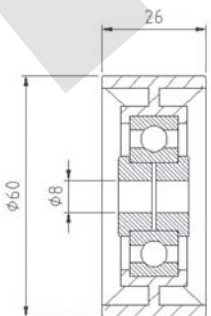





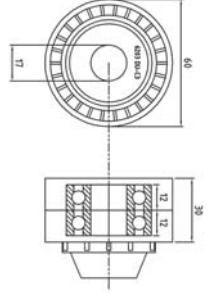



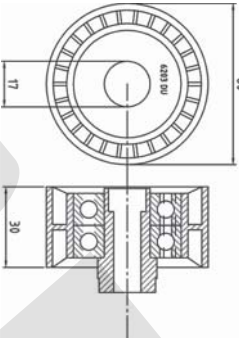

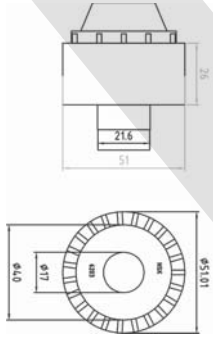

<p style="text-align: center;">5331</p>  <p style="text-align: center;">Ø70 X 27</p>		<p>Poly-V</p>	<p style="text-align: center;">575129 VKM 33013 F-122662</p>	<p style="text-align: center;">Tensor fijo de correa</p>	<p>Berlingo 1.8-1.9 dsl Xantia 1.9 dsl-td 2.1 td/206 1.9 dsl 405 / 406 / 306 605 2.1 td 806 1.9 dsl 2.1 td Partner 1.8-1.9 dsl</p>	
<p style="text-align: center;">5357</p>  <p style="text-align: center;">Ø85 X 26</p>		<p>Alternador</p>	<p style="text-align: center;">5751380 VKM 33002 F-123000</p>	<p style="text-align: center;">Tensor de correa circuito alternador-DA</p>	<p>306 / 405 / 406 BOXER EXPERT PARTNER BERLIGO XANTIA XSARA / ZX</p>	 
<p style="text-align: center;">5358</p>  <p style="text-align: center;">Ø85 X 22</p>		<p>Poly-V</p>	<p style="text-align: center;">6453760 VKM 33010 F-38931</p>	<p style="text-align: center;">Tensor de correa circuito alternador-AA</p>	<p>205 / 305 309 /405 / ZX</p>	 
<p style="text-align: center;">5367</p>  <p style="text-align: center;">Ø60 X 25</p>		<p>Poly-V</p>	<p style="text-align: center;">5751.74 VKM 33032 -----</p>	<p style="text-align: center;">Tensor de correa</p>	<p>206 1.9 dsl Berlingo 1.9 dsl Xsara 1.9 dsl Ducato 2.0</p>	 
<p style="text-align: center;">5369</p>  <p style="text-align: center;">Ø70 X 26</p>		<p>Poly-V</p>	<p style="text-align: center;">----- ----- -----</p>	<p style="text-align: center;">Tensor fijo de correa</p>	<p>Peugeot 206 Partner Berlingo Motor HDI</p>	

<p>5359</p>  <p>Ø60 X 28</p>		<p>Poly-V</p>	<p>5751.23 VKM 33040 F-123736</p>	<p>Tensor de correa automático</p>	<p>306 - 405 - Dsl. XANTIA Motor 1.9 y 2.1</p>	 
<p>5360</p>  <p>Ø60 X 34</p>		<p>Distribución</p>	<p>830.13 VKM 23241 F-122980</p>	<p>Tensor fijo correa de distribución.</p>	<p>PARTNER 205 / 306 405 / 406 / 806 EXPERT BERLINGO DUCATO</p>	  
<p>5361</p>  <p>Ø60 X 34</p>		<p>Distribución</p>	<p>0829.47/0829.33 VKM 13241 F-122216.3</p>	<p>Tensor de correa de distribución.</p>	<p>PARTNER 205 / 306 405 / 406 / 806 EXPERT BERLINGO DUCATO</p>	  
<p>5365</p>  <p>Ø60 X 29</p>		<p>Distribución</p>	<p>0829.88/1145947 VKM 13140 F-232828.3</p>	<p>Polea automático de correa</p>	<p>206 / 307 / 407 C3 / C4 XSARA ECOSPORT NUEVO FIESTA Motor 1.4</p>	

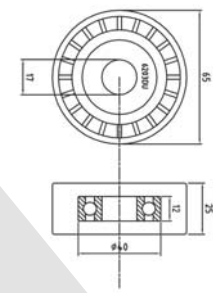
<p>5366</p>  <p>Ø70 X 30</p>		<p>Distribución</p>	<p>0829A0 VKM 13256 F-232829.5</p>	<p>Polea automático de correa</p>	<p>206 / 307 PARTNER BERLINGO C2 / C3 / C4 XSARA Motor 1.6 16v</p>	 
<p>5368</p>  <p>Ø70 X 27</p>		<p>Poly-V</p>	<p>5751.50 VKM 33018 F-122748.11</p>	<p>Tensor automático de correa</p>	<p>BERLINGO XSARA XSARA PICASSO 206 / PARTNER</p>	 
<p>5370</p>  <p>Ø70 X 27</p>		<p>Poly-V</p>	<p>----- ----- -----</p>	<p>Polea del tensor automático de correa</p>	<p>BERLINGO XSARA XSARA PICASSO 206 / PARTNER</p>	 
<p>5371</p>  <p>Ø95 X 26</p>		<p>Poly-V</p>	<p>6453.R8 VKM 33014 F-121722</p>	<p>Tensor de correa</p>	<p>605 2.5 DSL-TD BOXER 2.5 DSL-TD</p>	
<p>5372</p>  <p>Ø95 X 26</p>		<p>Poly-V</p>	<p>4007.E4 VKM 33015 F121977.1</p>	<p>Tensor de correa</p>	<p>BOXER 2.5 DSL TD</p>	

<p>5364</p>  <p>Ø55 X 26</p>		<p>Poly-V</p>	<p>---</p> <p>----</p> <p>----</p>	<p>Tensor de correa</p>	<p>206/306/405/406 Boxer Partner</p>	
<p>5373</p>  <p>Ø60 X 26</p>		<p>Poly-V</p>	<p>5751.30 VKM 33029 F-123787</p>	<p>Tensor de correa Poli V</p>	<p>Berlingo 1.8-1.9D Xantia 1.9D 1.9TD-2.1TD Xsara 1.8D-1.9D-1.9TD Xsara Picasso 1.8D-1.9D-1.9TD 206 1.9D /3 06 1.9D 406 1.9D-1.9 TD-2.1TD 806 1.9TD-2.1TD Expert 1.9D - 1.9TD</p>	
<p>5374</p>  <p>Ø60 X 25</p>		<p>Poly-V</p>	<p>---</p> <p>----</p> <p>----</p>	<p>Polea del tensor de correa Poli V</p>	<p>Berlingo 1.8-1.9D Xantia 1.9D 1.9TD-2.1TD Xsara 1.8D-1.9D-1.9TD Xsara Picasso 1.8D-1.9D-1.9TD 206 1.9D /3 06 1.9D 406 1.9D-1.9 TD-2.1TD 806 1.9TD-2.1TD Expert 1.9D - 1.9TD</p>	
<p>5375</p>  <p>Ø65 X 26 X Ø17</p>		<p>Alternador</p>	<p>---</p> <p>----</p> <p>----</p>	<p>Tensor tensora (Alternador A/A)</p>	<p>206</p>	
<p>5376</p>  <p>Ø60 X 26 X Ø8</p>		<p>Poly-V</p>	<p>---</p> <p>----</p> <p>----</p>	<p>Tensor tensora</p>	<p>306 / 405</p>	

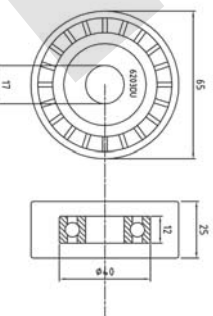
<p>5377</p>  <p>Ø60 X 24 X Ø17</p>		<p>Poly-V</p>	<p>7700102931 VKM 36031 F-124059</p>	<p>Tensor fijo de correa</p>	<p>Partner/Clio/ClioII kangoo/LagunaII Megane RT-RXE-RT TD Coupe Cabriolet Scenic/Berlingo Spazio3</p>	
<p>5378</p>  <p>Ø95 X 26</p>		<p>Alternador</p>	<p>5751.45 VKM 33004 F-123305.1</p>	<p>Tensor de correa</p>	<p>206 / 306 Expert Partner Berlingo Xsara 1.9 Dsl (Motor dw8)</p>	
<p>5379</p>  <p>Ø60 X 30 X Ø17</p>		<p>Poly-V</p>	<p>0830.48 VKM 23140 -----</p>	<p>Polea inversión guía</p>	<p>206/307/EXPERT PARTNER BERLINGO/C4 FIESTA FOCUS ECOSPORT 1.4</p>	
<p>5380</p>  <p>Ø60 X 30 X Ø17</p>		<p>Distribución</p>	<p>0830.51 VKM 23257 -----</p>	<p>Polea inversión guía</p>	<p>307/407 2.0 HDI 16V /C5 2.0 HDI 16V/C4 FOCUS 2.016V GALAXY MONDEO III 2,0</p>	
<p>5381</p>  <p>Ø60 X 30 X Ø10</p>		<p>Distribución</p>	<p>0830.46 VKM 23122 -----</p>	<p>Polea inversión guía</p>	<p>106 1.5 D SAXO 1.5 D</p>	

<p>5382</p>  <p>Ø60 X 30 X Ø10</p>		<p>Poly-V</p>	<p>5751.87 VKM 33044 -----</p>	<p>Polea inversión guía</p>	<p>ECOSPORT 03 FIESTA 1.4D C/AIRE /C3 XSARA 1.4 HDI 407 1.6HDI</p>	 
<p>5383</p>  <p>Ø60 X 30</p>		<p>Distribución</p>	<p>----- VKM 23256 -----</p>	<p>Polea inversión guía</p>	<p>206/207/307 PARTNER BERLINGO C3 1,6/C4 XSARA PICASSO 1,6</p>	 
<p>5384</p>  <p>Ø51 X 26</p>		<p>Poly-V</p>	<p>5751.88 VKM 33060 -----</p>	<p>Polea inversión guía</p>	<p>ECOSPORT03 FIESTA 02 1.4 D S/A /MAZDA 206 1.4 HDI XSARA 1.6 HDI BERLINGO/ C3</p>	 
<p>5385</p>  <p>Ø65 X 25 X Ø17</p>		<p>Poly-V</p>	<p>5751.C3/5751.61 VKM 33074 -----</p>	<p>Polea inversión guía</p>	<p>PEUGEOT 307 1.4/1.6 /C3/C4 BERLINGO FIESTA FOCUS II</p>	 
<p>5386</p>  <p>Ø65 X 26 X Ø17</p>		<p>Poly-V</p>	<p>5751.H6 VKM 33164 -----</p>	<p>Polea inversión guía</p>	<p>PEUGEOT 307 1.4/1.6 /C3/C4 BERLINGO FIESTA FOCUS II</p>	 







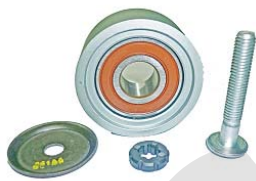
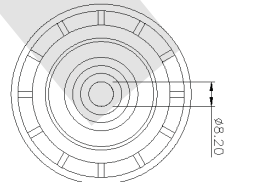

Catálogo Tensores de Correa

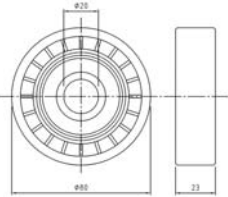
NeoTek

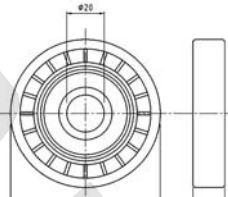

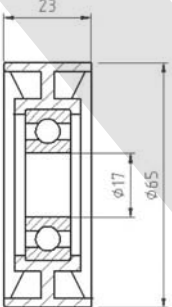
distribuidora rio

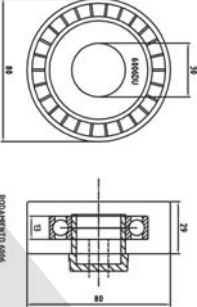
Código/Imágen	Plano/Medidas	Correa	Códigos Original/SKF/INA	Descripción del artículo	Aplicación	Marca
<p>5160</p>  <p>Ø56 X 25 X Ø17</p>	 	Alternador	552013640 93302612 VKM 04754A	Tensor metálico de alternador	Stilo Idea Punto 1.8 Corsa 1.8 Meriva	
<p>5149</p>  <p>Ø70 X 26 X Ø17</p>		Poly-V	904111025 90500229 1340541 ----- ----	Tensor fijo de correa	FIESTA DIESEL DUNA CORSA	
<p>5328</p>  <p>Ø60 X 25 X Ø17</p>	 	Poly-V	7700102931 VKM 36031 F-124059	Tensor fijo de correa	Partner/Clio ClioII/kangoo LagunaII/Megane RT-RXE-RT TD Coupe Cabriolet/Scenic Berlingo/Spazio3	
<p>5329</p> 	 	Poly-V	7700102931 VKM 36031 F-124059	Tensor fijo de correa	Partner/Clio ClioII/kangoo LagunaII Megane RT-RXE-RT TD Coupe/Cabriolet Scenic/Berlingo Spazio3	

<p>5153</p>  <p>Ø80 X 23 X Ø20</p>		<p>Poly-V</p>	<p>7641011 VKM 32009 F110627.4</p>	<p>Polea tensora (Tensor poly V)</p>	<p>TEMPRA 1.4 1.6 - 1.9 TIPO 1.4 -1.6 UNO 1.4-1.7 TD DUNA 1.7 DSL DUCATO 1.9 DSL PALIO SIENA 1.7 DSL-TD</p>	
<p>5154</p>  <p>Ø80 X 17 X Ø20</p>		<p>Poly-V</p>	<p>7749452 VKM 32011 F110790</p>	<p>Polea tensora (Tensor poly V)</p>	<p>PALIO 1.7 DSL-TD SIENA 1.7 DSL-TD STRADA 1.7 TD</p>	
<p>5155</p>  <p>Ø65X 23 X Ø17</p>		<p>Poly-V</p>	<p>----- ----- -----</p>	<p>Polea tensora (Alternador Aire)</p>	<p>PALIO (Motor Fire)</p>	
<p>5156</p>  <p>Ø80 X 29 X Ø10</p>		<p>Poly-V</p>	<p>46440604 VKM 32005 124197.51</p>	<p>Polea tensora (Alternador Aire)</p>	<p>DUNA 1,3 PALIO-96 MAREA 2,0 96 AL 2001 SIENA 1,3 BRAVO 2,0</p>	
<p>5159</p>  <p>Ø81 X 26 X Ø17</p>		<p>Alternador</p>	<p>----- VKM 32299 F-123758</p>	<p>Polea tensora (Alternador Aire)</p>	<p>PALIO SIENA ALTERNADOR 1.3 MPJ 8V</p>	